

# Design guide



RAINWATER SYSTEMS



version 1.0

# Rockflow: the flexible water retention system

Thank you for choosing the Rockflow system. This is the technical design guide for installing Rockflow. Technical calculations and design are included as part of all water-related aspects within a project. Making the right choices during the design phase increases system lifespan and correct performance. For instance, consider the location, the size of the buffer and how the buffer will be inspected and maintained. In this design guide we explain the design process and the reasoning behind certain choices. We also give you recommendations for the estimates. We give extensive and detailed descriptions of the steps and considerations required.

## Rockflow in brief

Rockflow can absorb up to 95% of its own volume in water. The [speed of absorption](#) is a match for even the heaviest of downpours. Rockflow has a permeability of >120 m/day, far higher than coarse sand: 30 m/day. Infiltration or delayed drainage can make the system available again within 24 hours. Since no geotextile is required, the underside of a Rockflow system also operates as an infiltration surface. In total, relatively little plastic is required to store and infiltrate water; only some pipework.

Rockflow can be installed under roads and hard surfacing, but also under greenspaces. The elements are available in various heights and thicknesses. They are also available in different strengths for different amounts of traffic. It is even possible to install it with a minimal cover layer of 40 cm.

The system is easy to handle and adaptable. It is possible to route cables and pipes that cross the buffer through the element. Rockflow is made of 97 % basalt and is 100 % recyclable.

For more information, see our [website](#).

In our technical downloads section you can find technical information such as tender texts, data sheets, safety instructions and the installation guide.



<https://www.youtube.com/watch?v=bkmVISyPYCE>



[rain.rockwool.com](http://rain.rockwool.com)

# Contents

Follow these steps to produce a robust design with easy maintenance throughout the system's lifespan.

<b>Short overview of the design steps</b>	<b>4</b>
Step 1: Determining the required Rockflow volume	4
Step 2 Choose: location and type of Rockflow system	5
Step 3: Installation height and depth and type of Rockflow element	6
Step 4: Hydraulic design of Rockflow	8
Step 5: Ease of maintenance and inspection	9
Step 6: Specification considerations	9
<b>Step 1: Basic principles of the Rockflow system</b>	<b>10</b>
Step 1a: Rainwater catchment area	10
Step 1b: Rain intensity	10
Step 1c: Storage requirements	12
Step 1d: Buffer capacity	13
<b>Step 2: Rockflow system location and type</b>	<b>14</b>
Step 2a: Choice of line buffer or central buffer	14
Step 2b: Sections: central buffer or multiple buffers	15
Step 3: Installation height and depth, type of Rockflow element	18
<b>Step 3a: Data required</b>	<b>18</b>
Step 3b: Determining the maximum Rockflow buffer height	19
Step 3c: Choosing Rockflow WM type element and height	20
Step 3d: Determining the length and width of a line buffer	20
Routing cables and pipes across the buffer	22
<b>Step 4: Hydraulic design of Rockflow</b>	<b>23</b>
Step 4a: Basic design principles	23
Step 4b: Hydraulic calculations	24
Hydraulic calculations for a Rockflow line buffer	24
Hydraulic calculations for a Rockflow central buffer	26
Step 4c: Ventilation and aeration of the Rockflow system	29
Step 4d: Draining a Rockflow buffer	29
Draining Rockflow using infiltration	29
Draining Rockflow with a delay	30
Step 4e: Emergency overflow	30
<b>Step 5: Ease of maintenance and inspection</b>	<b>31</b>
<b>Step 6: Important specification considerations</b>	<b>34</b>
Appendix 1: Overview of maximum axle load during construction and operation	35
Appendix 2: Venting and aeration, examples	37
Appendix 3: Design case with example calculations	38
Appendix 4: Important design considerations	40

# Short overview of the design steps

A brief summary of the entire Rockflow design guide is given below. For more detailed information, consult the thorough explanation later in the design guide.

## Minimum data required for a design

Data required	Value	Unit	Info required for
Rainwater catchment area	$A_{opp.}$	ha	Step 1a
Rain intensity/hydraulic design	$I_{showerlevel}$	l/s/ha	Step 1b
Storage requirements	B	mm	Step 1c
Maximum (peak) discharge to the Rockflow buffer	$Q_{max,A}$	l/s	Step 4b
Distance between ground level and groundwater level/ average maximum groundwater level	$R_{gr.lev.-av.gr.w.lev}$	m	Step 3a
Maximum permitted axle and wheel loads during construction and operation	$F_{max,BF} / F_{max,GF}$	tonnes	Step 3a / <a href="#">Appendix 1</a>
Permeability underlying soil (k value)	$K_{value}$	m/day	Step 4d

## Step 1: Determining the required Rockflow volume

$$\text{Rockflow [m}^3\text{]} = \frac{\text{Catchment area [ha]} * \text{Storage requirements [mm]} * 10}{\text{Empty space \% Rockflow [\%]}}$$

# Short overview of the design steps

## Step 2 Choose: location and type of Rockflow system

### 2A: Choose the solution type

Option 1: Line buffer

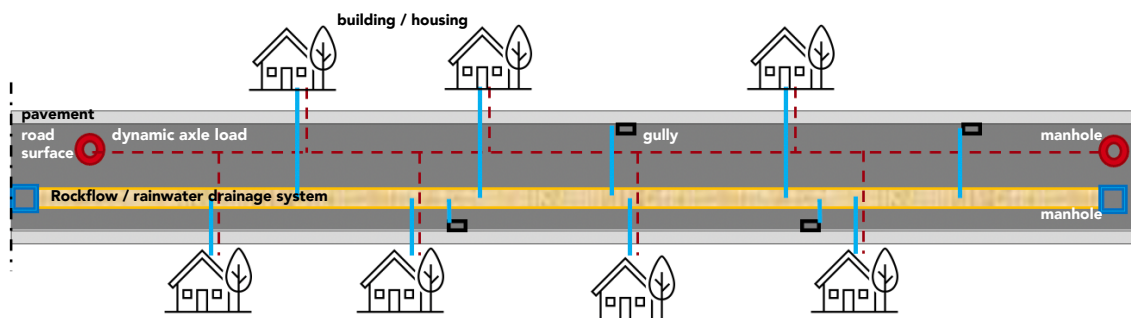

Option 2: Central buffer

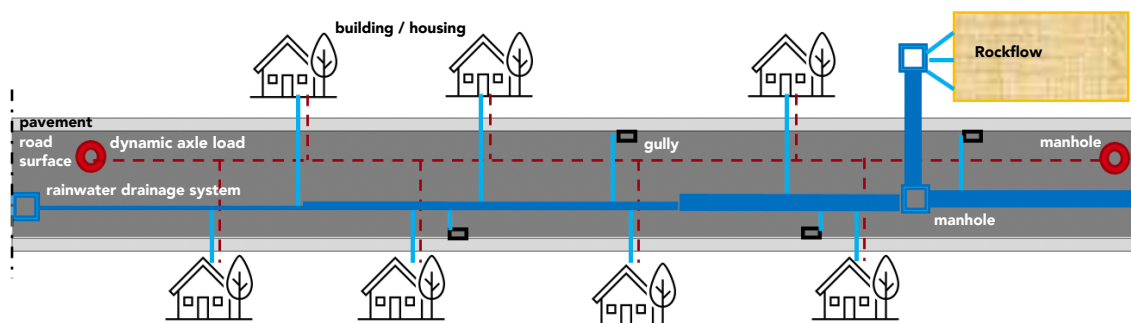

### 2B: Determine the number of locations for water retention

- 1 Storing the total storage requirements in 1 system
- 2 Storing the total storage requirements in several locations in the project area, possibly using several system types

# Short overview of the design steps

## Step 3: Installation height and depth and type of Rockflow element

Determine the distance between the future ground level and the groundwater level/average maximum groundwater level [.....m]

**3A: Determine the minimum cover layer during construction (excluding hard surfacing)** > see [Appendix 1 Overview of maximum axle load during construction and operation](#)

Is it necessary for construction traffic to drive over the Rockflow package during construction?

**Yes:** Determine the maximum axle load during construction and the minimum cover layer for type WM2005 elements.  
The final cover layer during operation = minimum construction cover layer + depth of hard surfacing

**No:** Determine the maximum axle load during operation and the minimum final cover layer for WM2005.  
Minimum cover layer during operation for WM2005 [.....m]

Rockflow element type WM2005			
During construction		During operation	
Minimum cover layer consisting of 0.30 m foundation + sand	Maximum permissible axle load/wheel load	Minimum cover layer with brick paving surfacing	Maximum permissible axle load/wheel load
axle load/wheel load			
30-45 cm	<3t / <0.8t	40-60 cm	<10t / <2.5t
45-65 cm	<6t / <1.5t	60-75 cm	<15t / <3.7t
>65 cm*	<10t / <2.5t	>75 cm*	<20t / <5.0t

\* Use this value for hard surfacing with asphalt

### 3B: Calculate the maximum Rockflow buffer height

Distance between ground level and average maximum groundwater level minus the minimum cover layer (see 3a) [.....m]

### 3C: Once the maximum height is known, choose between the standard Rockflow heights

Standard height: 0.50 m / 1.00 m: [.....m]

Non-standard heights are also possible: 0.33 m (not below traffic) and 0.66 m. It is possible to stack elements on top of each other, up to a maximum of 2 m.

**If there is not enough depth available, the WM2007 element may be the solution.** Return to step 3a and use the Rockflow WM2007 element [values](#). WM2007 has a higher load-bearing capacity and requires a thinner cover layer.

# Short overview of the design steps

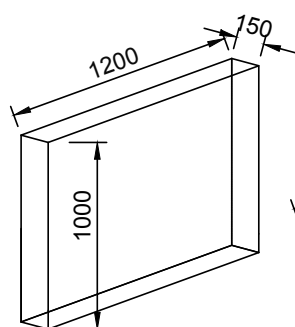
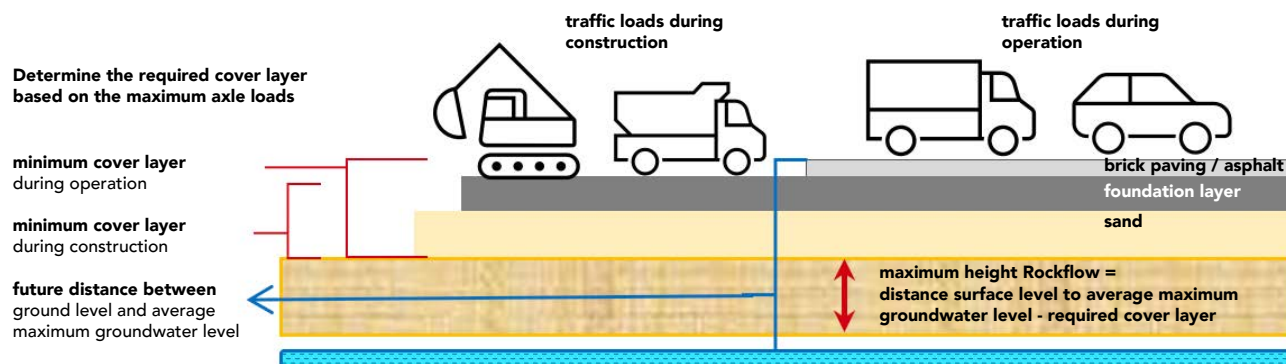

Rockflow WM2005 / WM2007  
1200 x 1000 x 150 mm

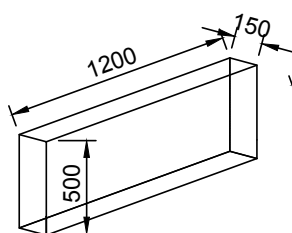

Rockflow WM2005 / WM2007  
1200 x 500 x 150 mm

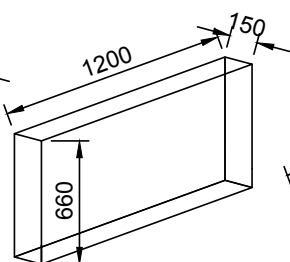

Rockflow WM2005 / WM2007  
1200 x 660 x 150 mm

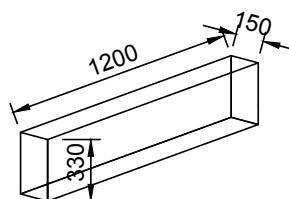

Rockflow WM2005 / WM2007  
1200 x 330 x 150 mm

# Short overview of the design steps

## Step 4: Hydraulic design of Rockflow

### 4a: Principles of basic design [LxWxH]

In the previous steps, the volume [m<sup>3</sup>] and the desired height [m] of the Rockflow system was determined.  
Width = multiples of 0.15 m Length = multiples of 1.20 m

### 4b: Hydraulic calculations

Water transport channels, each 1.2 m (basic size) for:

- Line buffer
- Central buffer (take care to provide sufficient Ø125 water transport channels)

### 4c: Venting and aeration pipes

- Air ventilation channel every 3.6 m
- Minimum 2 venting points per buffer
- Maximum every 50 m or per 100 m<sup>3</sup>

### 4d: Draining a Rockflow system

- 1 Infiltration to lower soil levels (k value of the lower soil level must be known)
- 2 Delayed drainage, 4 variants:
  - a Pinch valve in the overflow wall
  - b Opening in de overflow pipe
  - c Adjustable shutter
  - d Vertical infiltration tube

### 4e: Emergency overflow, 3 types:

- Overflow wall
- Overflow pipe in the drain45
- Overflow drain

## Basic principles

Rockflow WM2005 / WM2007

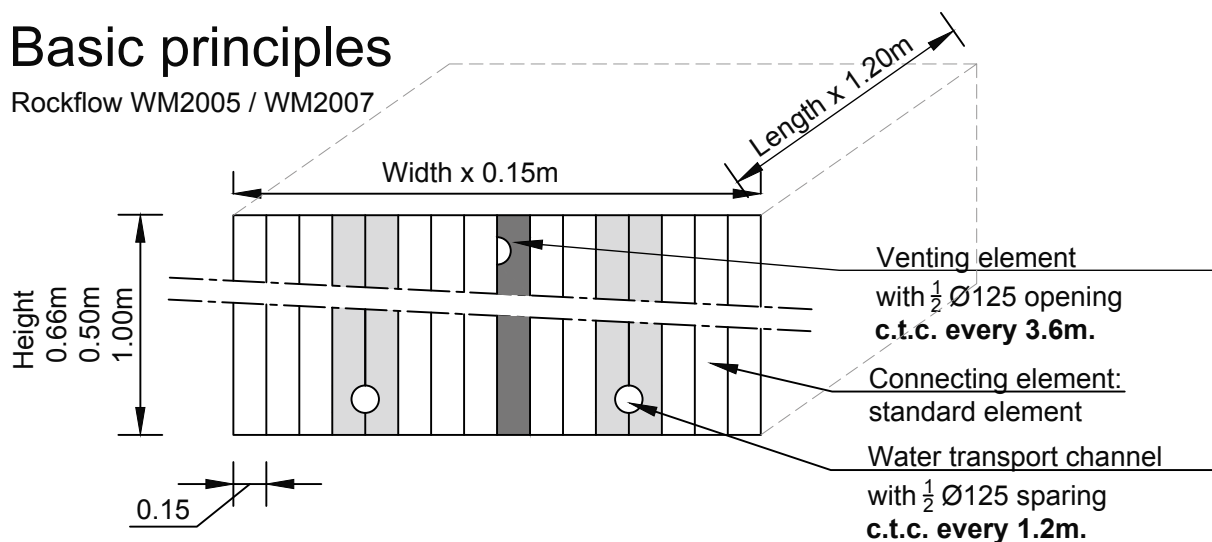

## Infiltratieberekening

$$l_{eff} = k^* \frac{(F_{wall} * O_{wall}) + (F_{soil} * O_{soil})}{24 * 10 * A_{hard,surf}}$$



# Short overview of the design steps

## Step 5: Ease of maintenance and inspection

The following aspects are important for ease of cleaning and inspection of the Rockflow system:

- Water transport channels must be accessible
- Bends in the Ø125 pipes should be <45° max. and a distance of min. 0.30 m from the following bend.
- Consider installing flushing equipment
- Sand trap in the adjacent inspection and access manholes
- No dead ends in the water transport channels
- Optimum drain connections to a line buffer

## Step 6: Specification considerations

For instance, add specifications for associated engineering work and quality considerations. You can download these from the Rockflow website.

We also advise you to attach the Rockwool installation guide and the acceptance inspection report as an appendix to the contract.

# Step 1: Basic principles of the Rockflow system

The following parameters are required to create a full design.

## Step 1a: Rainwater catchment area<sup>1</sup>

The hard surfacing in a certain area is used to calculate the amount of rainwater that the system needs to be able to drain away. The type of hard surfacing determines how much rainwater will flow into the buffer.

The degree of hard surfacing is expressed in the runoff coefficient, varying between 0 (unpaved, e.g. gardens) and 1 (fully paved, e.g. roads).



### Guideline:

$$\begin{aligned} \text{Rainwater catchment area} \\ &= \\ &100 \% \text{ of a paved area} \\ &+ \\ &50 \% \text{ of an unpaved area} \end{aligned}$$

## Step 1b: Rain intensity

To decide on the dimensions of a sewer system, it is common to make use of a theoretical design rainfall with a statistical recurrence interval.

In the Netherlands the sewer system is usually designed to Shower Level08 and calculated into the future using Level10. This allows you to assess where any drainage problems will occur within an area. Simulations of Level10 showers often allow for the surface to be temporarily flooded. However, this must not result in water damage in or close to buildings.

<sup>1</sup> <https://www.rainproof.nl/thema/water-afvoeren>

# Step 1: Basic principles of the Rockflow system

## GUIDELINES SEWER SYSTEM MODULE C2100

- Hydrogram LR C2100 bui 08 [mm / 5 min]
- Hydrogram LR C2100 bui 10 [mm / 5 min]
- Hydrogram LR C2100 bui 09 [mm / 5 min]
- Hydrogram LR C2100 bui 08 [l/s/ha]
- Hydrogram LR C2100 bui 10 [l/s/ha]
- Hydrogram LR C2100 bui 09 [l/s/ha]

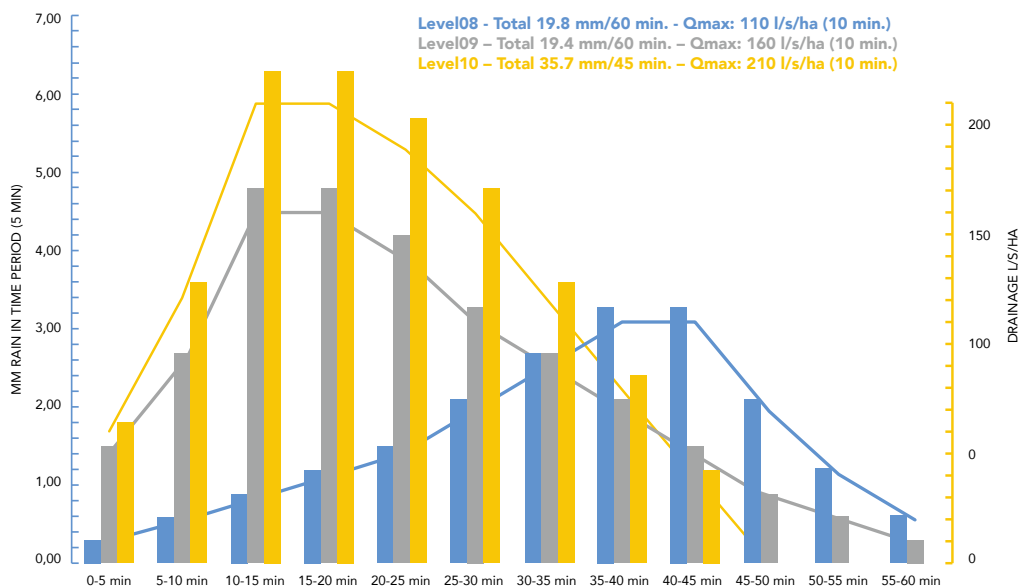

Diagram 1: Hydrograms of shower levels 08, 09 and 10<sup>2</sup> from the guidelines of RIONED, Dutch Centre of Expertise for urban drainage.

Shower level	Total precipitation in mm	Total shower duration	Maximum peak discharge	Maximum precipitation/precipitation intensity
Level08	19.8 mm	60 mins.	110 l/s/ha	3.3 mm/5 min. = +/- 40 mm/hour
Level09	29.4 mm	60 mins.	160 l/s/ha	4.8 mm/5 min. = +/- 58 mm/hour
Level10	35.7 mm	45 mins.	210 l/s/ha	6,3 mm/5 min. = +/- 76 mm/uur

Table 1: Design rainfall with statistical recurrence intervals according to Module C2100

In general, the sewer system 'upstream' from the Rockflow system adheres to the current Level08 norm. Given the changing climate, we expect that this drainage capacity will no longer be adequate. A number of municipalities are making their calculations for the future using Level09, e.g. the City of Amsterdam's Rainproof<sup>3</sup> programme. In the future, Level09 will probably become standard.

It is important to know the drainage capacity of the most recent rainwater drainage system located upstream from the Rockflow buffer in order to correctly calculate the dimensions of the Rockflow system.

<sup>2</sup> <https://www.riool.net/bui01-bui10>

<sup>3</sup> <https://www.rainproof.nl/thema/water-afvoeren>

# Step 1: Basic principles of the Rockflow system

## Step 1c: Storage requirements

The size of the rainwater buffer is usually determined primarily by the storage requirements. Storage requirements are expressed as mm per rainwater catchment surface area.

Different Dutch municipalities and water authorities/district water boards work according to a wide range of values for their storage requirements. The highest storage requirements are seen where the rainwater must eventually be discharged to the surface water belonging to a water authority or district water board. In that case, a storage requirement of 84-100 mm is set.

The size of a water retention system is related to the calculated risks and effects if a buffer is not empty in time for a following downpour. An estimate of the storage requirements can be based on the expected recurrence interval and rainfall intensity of a shower compared to the buffer's emptying time. Ultimately the authorities responsible for an area make the decision on the criteria set.



### Guideline:

Rainfall intensity for calculating sewer system:	Level08 (peak 110 l/s/ha)
Rockflow minimum recommendation (more futureproof)	Level09 (peak 160 l/s/ha)
Storage requirements, usually set by municipalities	60 mm (30-110 mm)
Storage requirements for discharge to surface water	84mm

# Step 1: Basic principles of the Rockflow system

## S 60 mm (30-110 mm)

Rockflow has the capacity to fill up to 95 % of the buffer's physical volume with water. To see an illustration of this, also watch our absorption/discharge [video](#):



Rockflow elements are available in two strength classes: WM2005 and WM2007.

Element strength classes/ types	Maximum % empty space	Dry mass per m <sup>3</sup> (minimum)
Rockflow WM2005 *	95 %	120 kg/m <sup>3</sup>
Rockflow WM2007	94 %	160 kg/m <sup>3</sup>

\* Over 95 % of our projects are designed using Rockflow type WM2005

Table 2: Two types of Rockflow elements

The total volume of the Rockflow elements is almost always determined according to the storage requirements. (Provided the storage requirement is greater than the total amount of rainfall in the design rainfall.)



### Volume calculation for the Rockflow water retention system

Water retention volume [m<sup>3</sup>] = Catchment area [m<sup>2</sup>] \* Storage requirements [m]

$$\text{Rockflow volume [m}^3\text{]} = \frac{\text{Water retention volume [m}^3\text{]}}{\text{Rockflow empty space [\%]}}$$

For a case and example calculation, see [Appendix 3](#)

# Step 2 Rockflow system location and type

The volume of the Rockflow system that needs to be installed is now known. The following step is to determine the shape and location of the buffer or buffers. The available space in the project area often determines which type of buffer is possible and its dimensions.

## Step 2a: Choice between line buffer or central buffer

- 1 LINE BUFFER: a long, narrow buffer with multiple rainwater supply connections on the long side (such as gullies and rainwater drainage from buildings)
- 2 CENTRAL BUFFER: square or rectangular with the primary rainwater supply on the short side or sides of the buffer. Secondary connections on the long side are also possible.

### A line buffer in a street

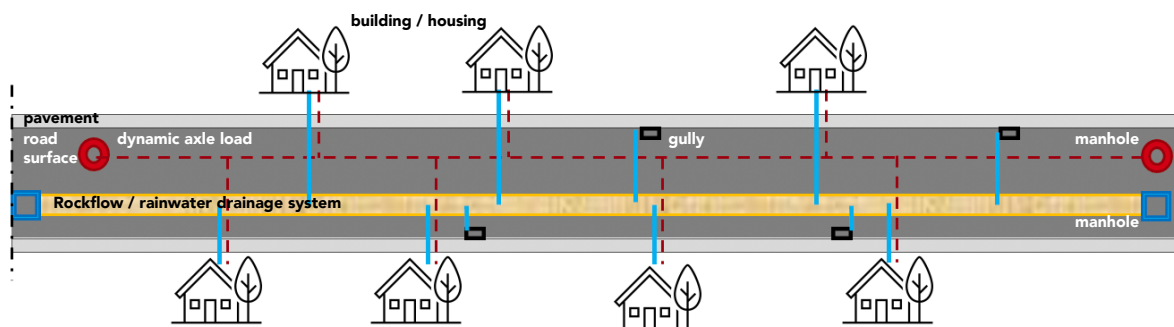

Figure 1: Line buffer

### A central buffer in a street

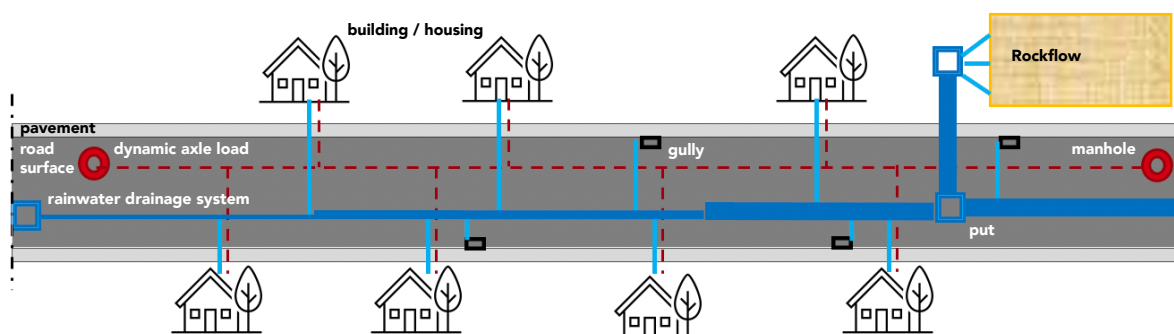

Figure 2: Central buffer

# Step 2 Rockflow system location and type

On a square or car park

Choice between line buffer or central buffer

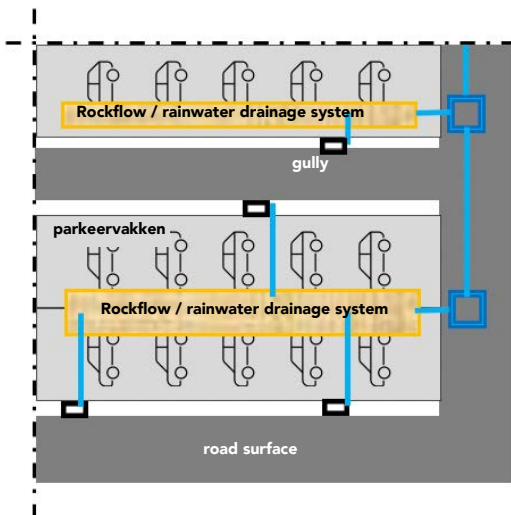

Figure 3: Line buffer

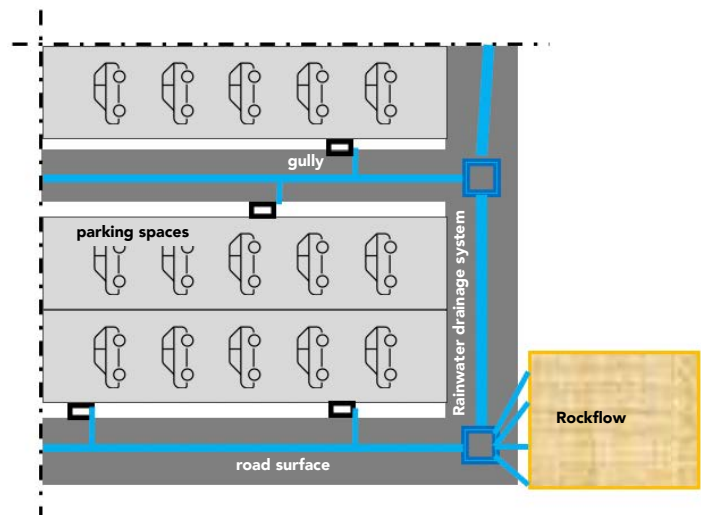

Figure 4: Central buffer

## Overflow and retention basins

An overflow system or overflow basin is usually present in a sewer system. Although a sewer is sized for a certain rainfall intensity, there is always the chance of a more extreme downpour. The overflow is usually found at the far end of the sewer pipe system. For a gravity sewer system, the overflow is often at the lowest point. Because the overflow is intended to transport excess water away from the area, the pipes increase in size the nearer they are to the overflow. This often creates problems in practice because the pipes take up a great deal of space underground. This principle is also an issue when making choices about infiltration buffers.

## Step 2b: Sections: central buffer or multiple buffers

Rockflow systems can be installed as a central buffer or in multiple buffer areas. If possible, multiple small buffer areas are preferable. Heavy downpours are now becoming increasingly common. For transport of water from heavy downpours and higher peak transport from a large catchment area to a central buffer, the diameter of the pipes must increase in size as they near the buffer. Particularly in urban areas, large diameter pipes are not easy to install due to the presence of existing underground infrastructure and the restricted working space.

In such urban cases, a good alternative is to implement multiple small buffers.

Choose an option for draining rainwater from the project area:

- 1 One large central buffer
- 2 Multiple smaller buffers

# Step 2 Rockflow system location and type

## Principle longitudinal section of 1 central buffer

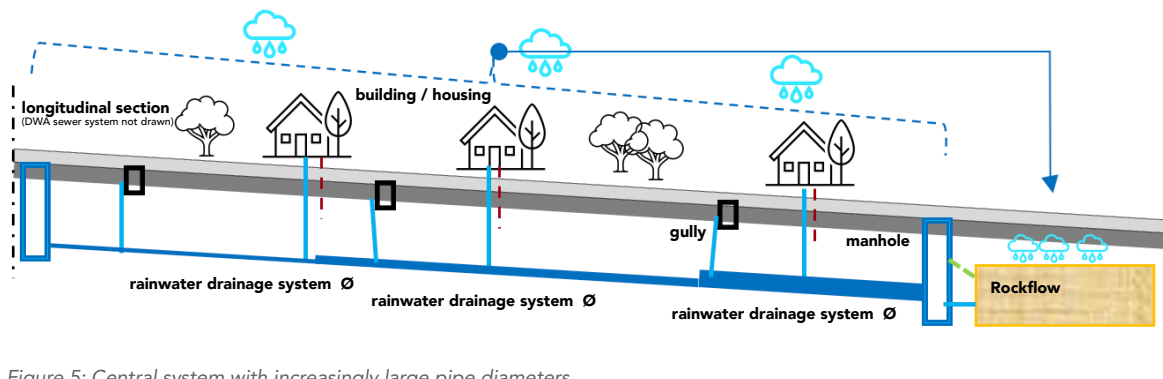

Figure 5: Central system with increasingly large pipe diameters

## Principle longitudinal section of multiple smaller buffers

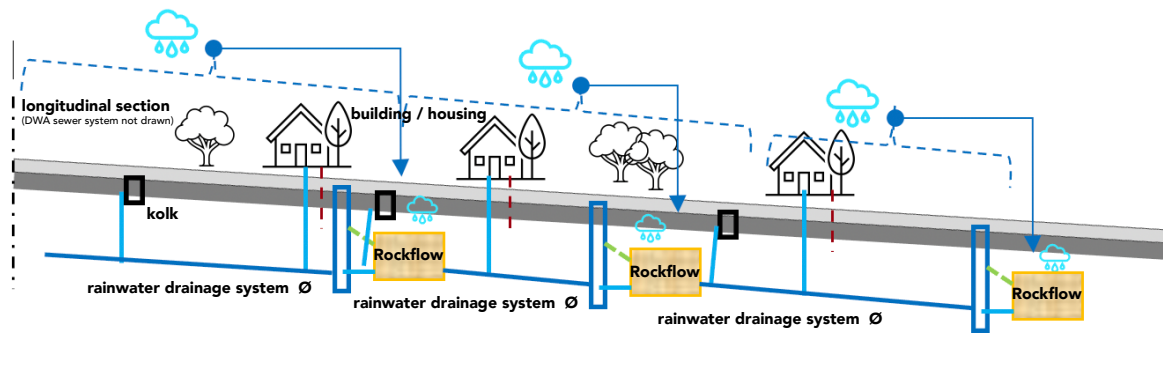

Figure 6: Multiple sections with smaller buffers so that fewer large-diameter pipes are required



# Step 2 Rockflow system location and type

Use the table below to help you choose the best option.

Most important consideration	Line buffer	Single central buffer	Multiple smaller buffers
Excavation (Rockflow, incl. piping)	Least amount of excavation because little additional piping is required.	Highest amount of excavation, many pipelines with larger diameters.	Slightly more excavation than a line buffer, due to the smaller connecting pipes between the buffers.
Space required for the whole system (Rockflow and pipelines)	Least space, usually under the road surface next to the Dry weather flow (DWF) sewer pipe.	Most space; in addition to space for pipelines, space for a larger central buffer is also required.	Probably average space, depending on the number, shape and location of the buffers.
Flexibility in phasing the engineering work	Can be carried out one street or section at a time. If installed at the same time as the DWF system, DWF takes precedence.	Install the buffer first, then the upstream rainwater drainage system.	Each buffer area can be tackled separately. For installation at the same time as the DWF system, DWF takes precedence.
Flexibility of implementation, e.g. routing of cables and pipes crossing the buffer.	Most flexible system. Pipelines can easily cross the Rockflow package.	Least flexible. A set location is often chosen for the buffer. It is often difficult to adjust existing cables and pipelines. In addition, pipelines with larger diameters are often necessary. These cannot be easily modified.	Smaller buffers with smaller pipe diameters can usually be moved slightly or modified.
Local rainwater processing / local groundwater replenishment / combatting drying out of lower soil levels (if infiltration is possible)	Water infiltrates directly, virtually no transport. If infiltration is not possible or permitted, the system can rapidly buffer the water and drain it with a delay.	Draining rainwater to another area for processing / infiltration. Not useful for drought control. If infiltration is not possible or permitted in the upstream area, then infiltration elsewhere is an option.	Combination of a line buffer and a central buffer. Enables more local infiltration and is more useful for drought control.
Risk of local flooding (due to an extreme downpour that exceeds the hydraulic capacity of the system)	Due to the short pipelines with enough gullies available, the system will fill up until it reaches storage requirements. The amount of water is not expected to rise above ground level. This system also has the greatest infiltration surface area.	Due to the long pipeline system designed for a specific hydraulic capacity, it is more likely that the street will be flooded during an extreme downpour. This system also has the smallest infiltration surface area.	Even though the smaller buffers are connected to each other, the risk of local flooding during an extreme downpour is slightly higher than with a line buffer.

Table 3: Decision matrix: line buffer vs central buffer vs multiple smaller systems



## Guideline:

If possible, install a line buffer or several small buffers.

This allows you to retain the rainwater where it fell and infiltrate it in situ (if that is possible). Due to the relatively short distance between the gully/rainwater drainage system outlet and the Rockflow package, smaller pipeline diameters are required. Implementation and price are cheaper.

In addition, backflow into the system is virtually impossible. A Rockflow buffer always fills up rapidly.

# Step 3: Installation height and depth and type of Rockflow

Now that you have determined the Rockflow volume and the desired system, you can choose the correct size. In this step we determine the dimensions: length x width x height.

You can also choose the correct dimensions for a Rockflow buffer up to 50 m<sup>3</sup> using our online tool: [www.rockflow.app](http://www.rockflow.app)

## Step 3a: Data required

Before you determine the height of the Rockflow system, you need to know a number of details, i.e.:

### 1 The area's height above sea level

If the height above sea level is not yet known, you can consult the Dutch altitude map: [www.ahn.nl](http://www.ahn.nl)

The ground level altitude on site is essential for calculating the available space between ground level and the groundwater table.

### 2 Groundwater level or average maximum groundwater level

To ensure that a buffer is not installed in or beneath the groundwater level, you need to know the groundwater level and also the average maximum groundwater level. The majority of clients specify that a buffer/infiltration buffer is installed above the average maximum groundwater level. You can determine this by installing monitoring pipes near the proposed project site. It is sometimes also possible to find information via <https://www.dinoloket.nl> (in Dutch) or via the municipal groundwater monitoring network.

### 3 Maximum traffic loads and axle loads during the construction and operational phases.

The maximum axle load or wheel load determines installation depth and Rockflow element type (WM2005 or WM2007). If construction traffic has to drive over the Rockflow buffer, the installation depth needs to be greater. To determine the correct installation depth and cover layer use the table in [Appendix 1](#) - Overview of maximum axle load during construction and operation phases.

### 4 Altitude of the final rainwater drainage system pipe (inside of base of pipe) before the Rockflow buffer.

The altitude of the future rainwater drainage sewer system may affect the cover layer. Depending on the system and on the hydraulic calculations, there may be standing water in the sewer system when the buffer is completely full.

#### A few tips

- In a residential street with many crossing cables and pipelines, implementation is easier using a deeper cover layer (>75 cm). The buffer can then usually be installed below the cables and pipelines.
- WM2005 elements are cheaper than WM2007; only use the latter if essential.
- It is preferable to install the Rockflow buffer in a new housing development when the houses are ready for occupation. If this is not possible, it is vital to provide sufficient coverage to the Rockflow elements during construction (>0.75 m) and to protect them or cover them with protective road plates to prevent damage by construction vehicles.
- Wherever possible, construction vehicles should install the Rockflow buffer 'from the side' rather than underneath the traffic route. Only drive over Rockflow when the entire cover layer is present and can be put into use.
- N.B. If an asphalt layer will be used above the Rockflow buffer during operation, ensure that there is an adequate cover layer (sand and foundation layer) over the Rockflow buffer. Asphalt lorries that drive over the compacted rubble foundation during the construction phase form an extra heavy load. Refer to the example calculation in [appendix 3](#), step 3.
- If cranes are used during construction, do not place outriggers on top of an infiltration system. If this is unavoidable, take appropriate measures to disperse the load. In general, the point loads of an outrigger are extremely high.

# Step 3: Installation height and depth and type of Rockflow

## Step 3b: Determining the maximum Rockflow buffer height

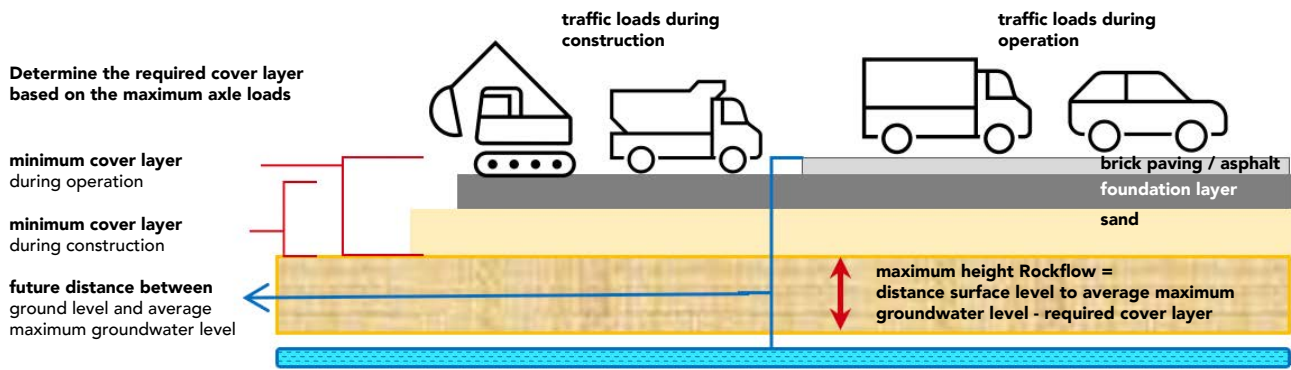

Figure 7: Determining the Rockflow element height and type



### Determining maximum height of the buffer / infiltration buffer

Distance between future ground level and average maximum groundwater level	[... m]
Governing required cover layer construction/operational phase	[... m] -
Maximum height of buffer =	[... m]

# Step 3: Installation height and depth and type of Rockflow

## Step 3c: Choosing WM type Rockflow element and height

Once you know the maximum height and the required cover layer, you can choose the type of element and its height.

Element strength classes/ types	Standard heights	Other heights
Rockflow WM2005 *	0.5 m + 1.00 m	0.33 m + 0.66 m
Rockflow WM2007	0.5 m + 1.00 m	0.33 m + 0.66 m

\*De elementen van 0,33m hoog zijn in principe niet geschikt voor onder verharding met verkeer. Het is ook mogelijk om twee elementen op elkaar te plaatsen, zodat een buffer met een maximale hoogte van 2m gemaakt kan worden.



If the underlying soil levels have an extremely poor infiltration value (low k value), it could be advisable to choose shorter elements. This allows you to create a greater infiltration surface area enabling water to infiltrate relatively rapidly in spite of the low k value. See step 4 in this document.

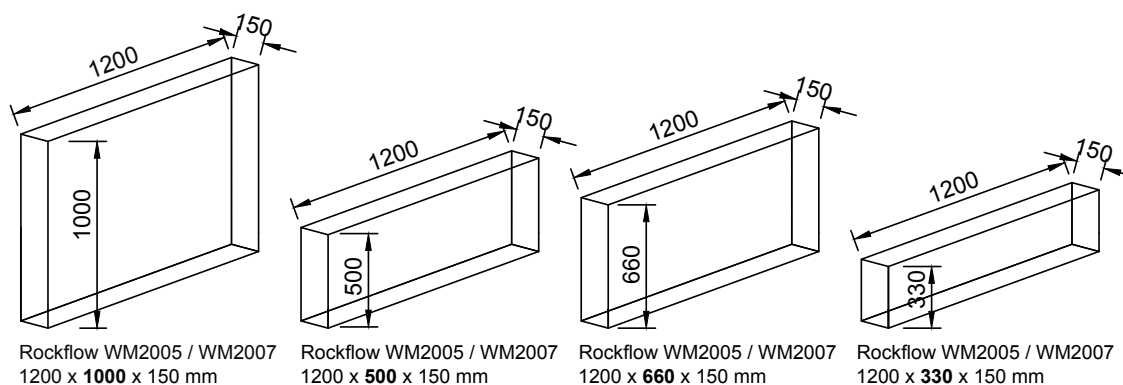

Figure 8: Dimensions of elements

The Rockflow WM elements have a fixed width of 0.15 m and a length of 1.20 m.



**Step 3:** For a case and example calculation, see [Appendix 3](#)

# Step 3: Installation height and depth and type of Rockflow

## Step 3d: Determining the length and width of a line buffer



In practice, the length of a line buffer is not always the entire length of the street. The presence of cables, pipelines and crossing domestic connections means it is often necessary to interrupt a line buffer. Our guideline is: the effective installation length in a street is approx. 80 % of the actual length (between the curves).

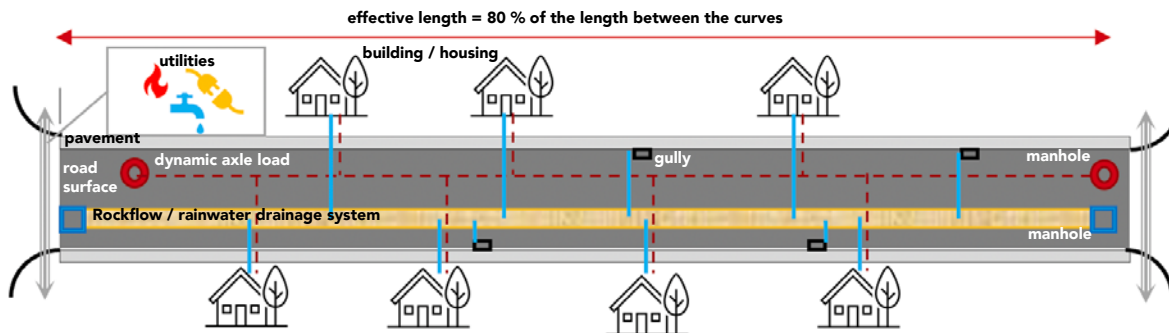

Figure 9: Effective length

### Length = multiples of 1.20 m

Because the Rockflow elements are 1.20 m long, the total length of the buffer must be a multiple of 1.20 m. E.g. If you have several streets with a total length of 1 km, the effective length for designing the buffer is approx. 800 m. The actual implemented length is therefore 800.4 m: a series of 667 x 1.2 m length elements.

For control and maintenance purposes, we recommend a maximum line buffer length of 40 m if the buffer is accessible on one side only (via a manhole) and has rainwater supply from one side; 80 m if there is access and rainwater supply on two sides (i.e. for a line buffer in a street, there should be a minimum of one inspection manhole per 80 m).

Refer to Step 4 for the maximum hydraulic dimensions of a line buffer / central buffer

### Width = multiples of 0.15 m in length

Base the width calculation on the previously calculated total buffer capacity and the available implementation length. The required buffer capacity in this sample calculation is 634 m<sup>3</sup>. If we divide this by the length of 800.4 m, the required minimum width is 0.79 m<sup>2</sup>. Since the Rockflow elements in this example are 1.0 m high and 0.15 m wide, the total width must be a multiple of 0.15 m. This gives us a result of 0.90 m, i.e. 6 elements with a width of 0.15 m.

### Technical drawing of a cross section

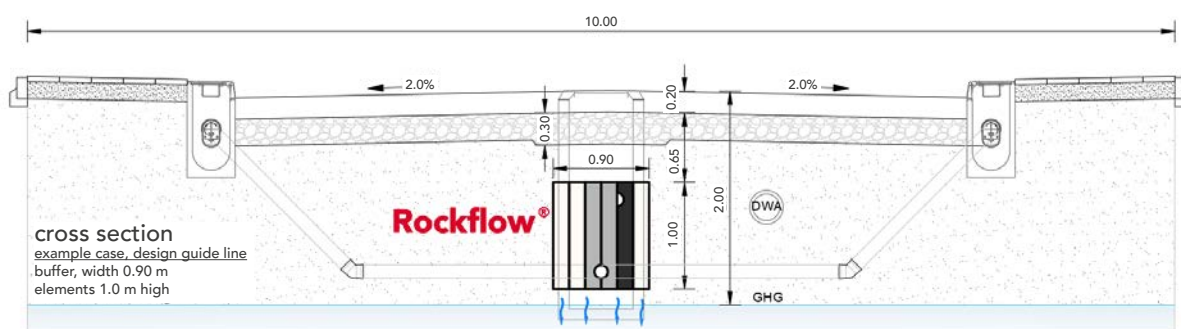

Figure 10: Design example

# Step 3: Installation height and depth and type of Rockflow



## Determining the size of the infiltration buffer

Choose height depending on cover layer and groundwater level: 0.5/0.66/1.00 m (max. 2 m)

Surface area Rockflow buffer [m<sup>2</sup>]: buffer capacity [m<sup>3</sup>]/element height [m]

Length = multiples of 1.20 m (size of element)

Maximum length for single-sided supply 40 m. For two-sided supply 80 m.

Width = multiple of 0.15 m (size of element)

## Routing cables and pipes across the buffer

In the case of a line buffer in a residential street, there is a high probability that existing cables and pipelines will cross the package. For flexible pipelines and smaller diameter cables (**Ps**), there is the option of cutting a section out of the stone wool to allow the pipelines or cables to cross the package. For larger diameter pipelines (**Pb**) it is simpler to interrupt the Rockflow package. It is vital to connect the Rockflow's internal channels (**C**) using Ø125 pipes.

As mentioned previously, for ease of implementation, we recommend that you adhere to a cover layer of over 75 cm on top of the Rockflow elements, both during the construction phase and above crossing cables and pipelines. The groundwater table must be deep enough to permit this.

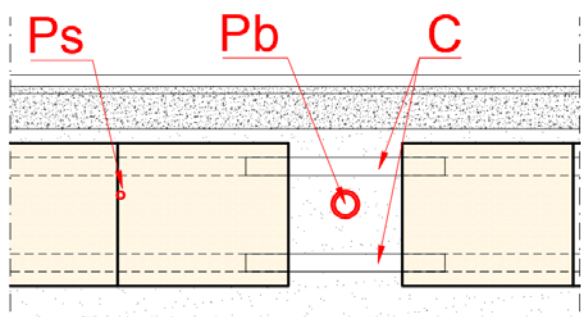

Figure 11: Routing cables and pipes across the buffer

# Step 4: Hydraulic design of Rockflow

In this step we define the number of water transport channels (WATER IN) and the number of venting and aeration channels (AIR OUT) in a Rockflow buffer. The channels in a Rockflow buffer are essential to enable the buffer to fill up during the design rainfall specified (amount and duration).

## Step 4a: Basic design principles

If a buffer is designed according to the principles below, the Rockflow system is almost always able to work rapidly enough to process a peak flow according to a Level09 shower.

### Basic principles

Rockflow WM2005 / WM2007

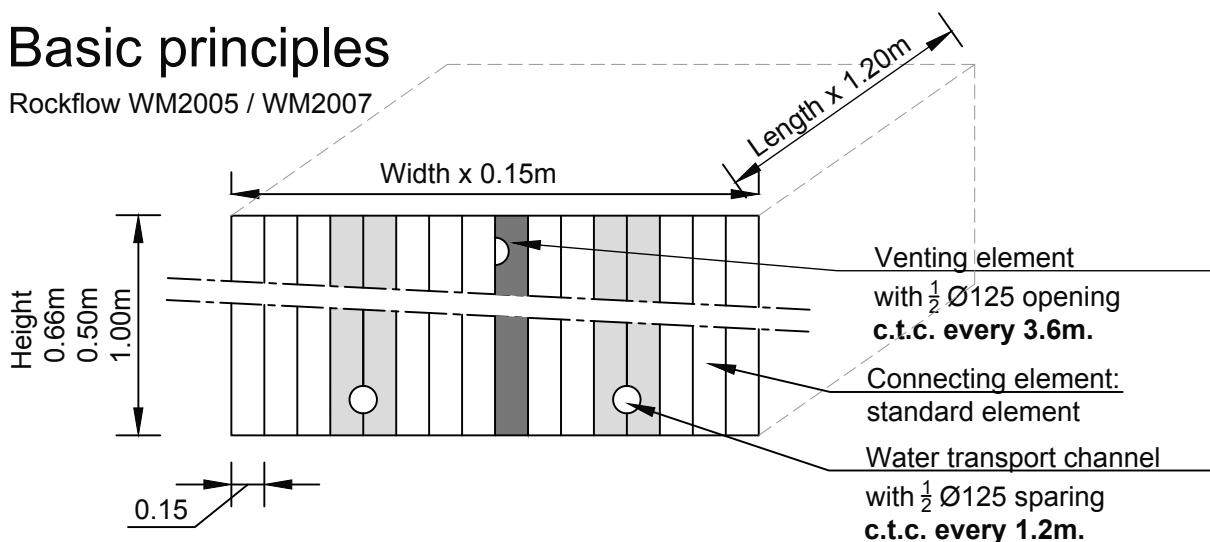

Figure 12: Basic design principles

The water transport channels have a c.t.c. distance of 1.20 m for a buffer height of 1.0 m or higher. For lower buffers, a c.t.c. distance of 1.5 m can be followed.

**The number of channels (i.e. rainwater supply points) determines the hydraulic calculations (filling time) of the Rockflow system.** The Rockflow stone wool itself is not the limiting factor for filling the system as the permeability of stone wool is extremely high. For an example, watch the video about stone wool's absorption and discharge of water. The permeability (k value) has been determined by Deltares (4) as approx. 120 m/day, or 1 - 1.5 mm/sec. Where there are larger pressure differences, large 'absorption deficits' are possible. The capacity of the supply channels is usually the determining factor for the filling speed of the Rockflow system.



<sup>4</sup> Determined according to norm NEN-EN-ISO 17892-11.

Watch the [video](#) about stone wool's absorption and discharge of water.

## Step 4: Hydraulic design of Rockflow

The number and length of the supply channels determine the Rockwool system's filling time. Rockflow stone wool is sufficiently porous that this is not the limiting factor.

The rainwater is brought through a Ø125 mm PVC connection into the Ø125 mm channels in the stone wool package. In a line buffer, the rainwater flows directly into the Rockflow channel. This usually arrives via a gully or a domestic rainwater drainage system. In a central buffer, the rainwater is collected by a rainwater drainage pipeline system, then divided over the Rockflow system via a manhole.

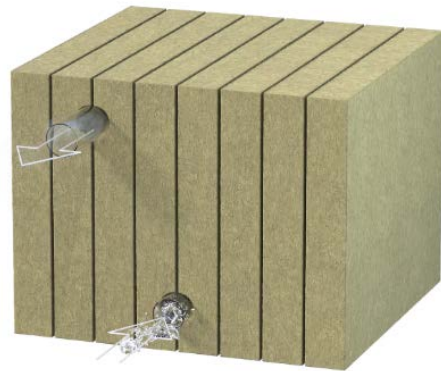

Figure 13: Example of the structure

### Step 4b: Hydraulic calculations

Hydraulic calculations for a line buffer or a central buffer require a different approach.

The calculations below are done using a simplified and conservative methodology. You can also always model the Rockflow system using a hydraulic modelling package such as Infoworks or Mike+. Ask us about instructions for doing this.

#### Hydraulic calculations for a Rockflow line buffer

A line buffer should be fed from the side with rainwater at very regular distances. Since the standard maximum distance between two gullies is 30 m, the distance between two supply points is usually never more than 30 m. The current guideline is that a gully should drain a maximum of 250 m<sup>2</sup> of hard surfacing.

If you calculate according to these rules, the drainage capacity per gully should be 4.0 l/s (for Level09) or 5.25 l/s (for Level10). This is the equivalent of 18.9 m<sup>3</sup>/h for Level10. Although the drainage capacity of gullies is extremely variable, we assume that the gullies can cope with this flow. Now we can assess if the filling speed is lower than Rockflow's maximum flow rate. As determined earlier, this is at least 80 m/day, assuming a maximum width of 1.2 m (with a single filling channel) and a gap of 30 m between gullies. This is the equivalent of a filling speed of  $18.9/1.3*30 = 0.5$  m/h, or 12 m per day. This is much less than 80 m/day, meaning the system has more than sufficient capacity, even for Level10 rainfall. This is the case for the majority of line buffers because there are regular side connections for rainwater from gullies and the rainwater drainage system connections.

In the future, the standard maximum distance between two gullies will become smaller due to increasing rainfall intensity. The surface area norm will also no longer be adequate. We are already seeing specifications using the guideline of 100 m<sup>2</sup> per gully for asphalt and 120 m<sup>2</sup> for permeable paving.



# Step 4: Hydraulic design of Rockflow

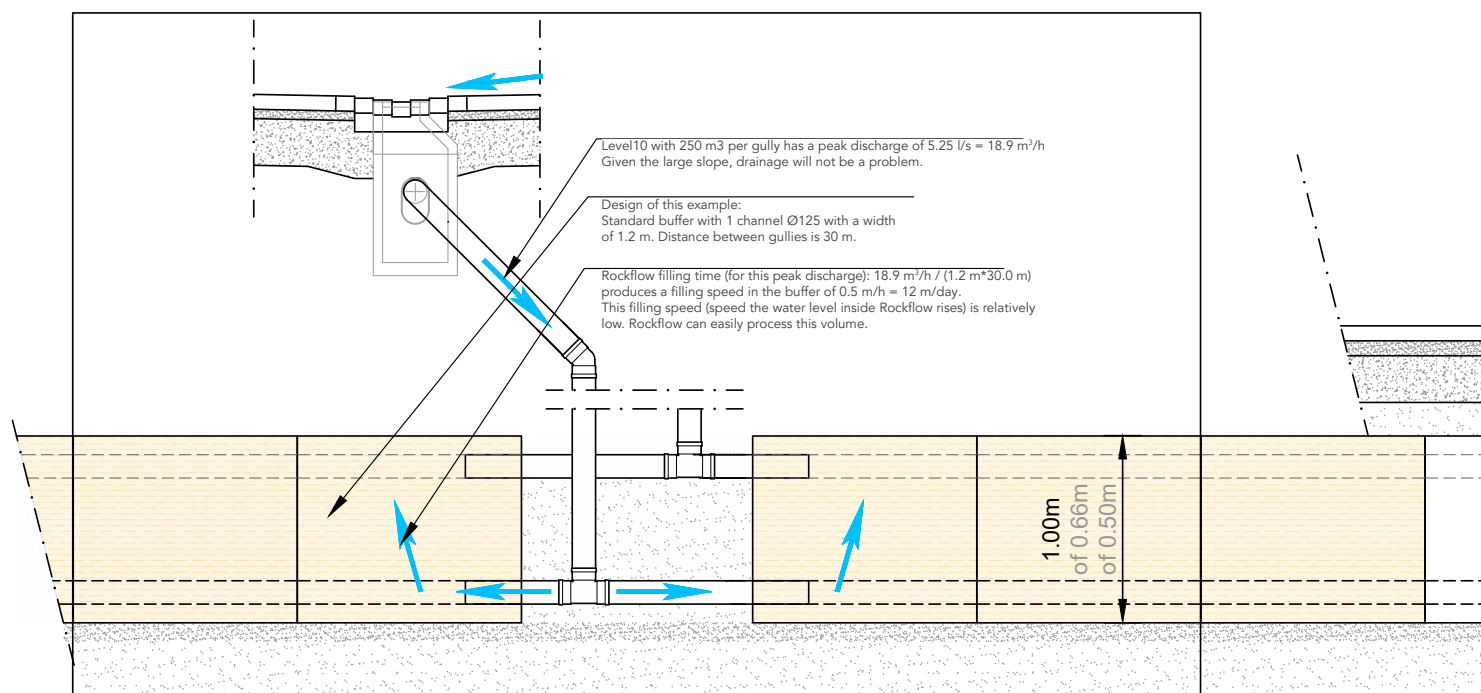

Figure 14: Longitudinal section of a line buffer with a gully connection

The maximum length of a line buffer is primarily determined by the possibilities for inspection and maintenance of the line buffer. To allow full inspection and cleaning of a line buffer, the maximum distance between manholes is 80 m, if it can be maintained from two sides. If maintenance is only possible from one side, then the maximum distance is 40 m. A distance of 40 m means it can be cleaned using a cleaning vehicle. If the distance is longer, it becomes difficult for the spraying nozzle to build up sufficient pressure and to move forward. We will return to this in Step 5, inspection and maintenance.

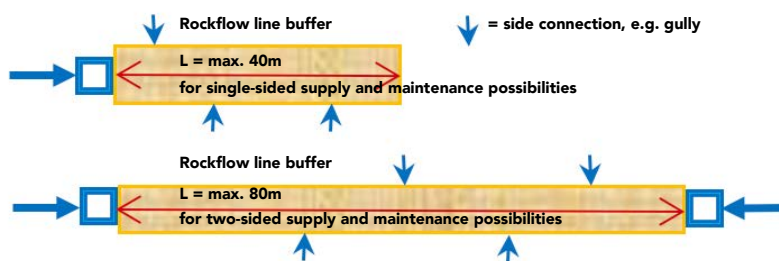

Figure 15: Maximum length buffer needed for inspection and maintenance



## Guidelines for a LINE BUFFER

The hydraulic capacity of a line buffer is rarely the limiting factor

### Dimensions:

Width: Internal Rockflow channels every 0.6-1.5 m (usually 1.2 m)

Height: Choose based on cover layer; 0.50 m, 0.66 m or 1.00 m

Length: Maximum 80 m between two manholes for inspection and cleaning.

# Step 4: Hydraulic design of Rockflow

## Hydraulic calculations for a Rockflow central infiltration buffer

For central buffers, particularly with a length of 24 m or more, it is essential to carefully design the hydraulic system. For single-sided filling with no side supply points, the hydraulic head can increase. This is usually not a problem because peak supply is generally not at the end of a downpour when the system is already almost full. Moreover, in general buffers are designed to comply with far higher storage requirements than the hydraulic shower.

- 1 The rainwater drainage system upstream of the Rockflow buffer determines the maximum peak discharge:  $Q_{\max.A} \rightarrow \text{l/s}$   
N.B. This is not the same as the maximum storage requirements; (see point 1 in Figure 17).
- 2 The buffer's distribution manhole where the  $\varnothing 125$  connections meet ensure that the water can flow into the Rockflow buffer. The number of connections can be calculated as follows:

$$\text{Minimum number } \varnothing 125 = Q_{\max.A} / Q_{\max. \varnothing 125 (\Delta H=0.2 \text{ m; } l=5 \text{ m})}$$

$$\text{Minimum number } \varnothing 125 = Q_{\max.A} [\text{l/s}] / 16 [\text{l/s}] \text{ (see point 2 in Figure 17)}$$

- 3 Determining the dimensions of a buffer:
  - a **Height = 0.50 m or 1.00 m** (already chosen based on the cover layer; see point 3b in Figure 17).
  - b **Width = Number  $\varnothing 125$  \* 1.2 m** (c.t.c. distance of channels in Rockflow at  $h=1.0$ ). We recommend dividing buffers that are wider than 10 to 12 m widthways. Compacting of the additional sand is extremely important for wider buffers. N.B. For an extremely high  $Q_{\max.A} [\text{l/s}]$  it is sometimes necessary to fit the supply channels close together ( $<1.2 \text{ m}$ ). If the 1.2 m guideline is followed, the buffer can become too wide. (See point 3a in Figure 17).
  - c Length: see point 3c in Figure 17.

$$\text{Length} = \frac{\text{Storage requirements [m}^3\text{]}}{(\text{Width[m]} * \text{Height[m]} * \text{Empty space \% Rockflow})}$$

- d Width : Length ratio = 1.0 :  $>1.2$
- e Check if there is sufficient absorption capacity through the channels:

$$\frac{Q_{\max.A}}{\text{Number } \varnothing 125 * \text{Length}} < 0.4$$

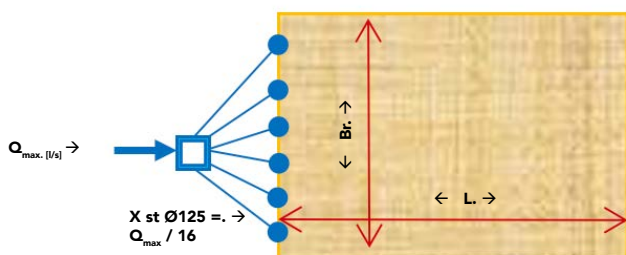

- a: surface area buffer = contents [m<sup>3</sup>] / height of element [m<sup>1</sup>]
- L. = max. 24 m (up to 40 m possible under certain circumstances)
- Br. = number  $\varnothing 125$  connections x 1.2 m (0.6 m-1,5m)

Figure 16: Dimensions of a buffer and number of connections (top view)

# Step 4: Hydraulic design of Rockflow

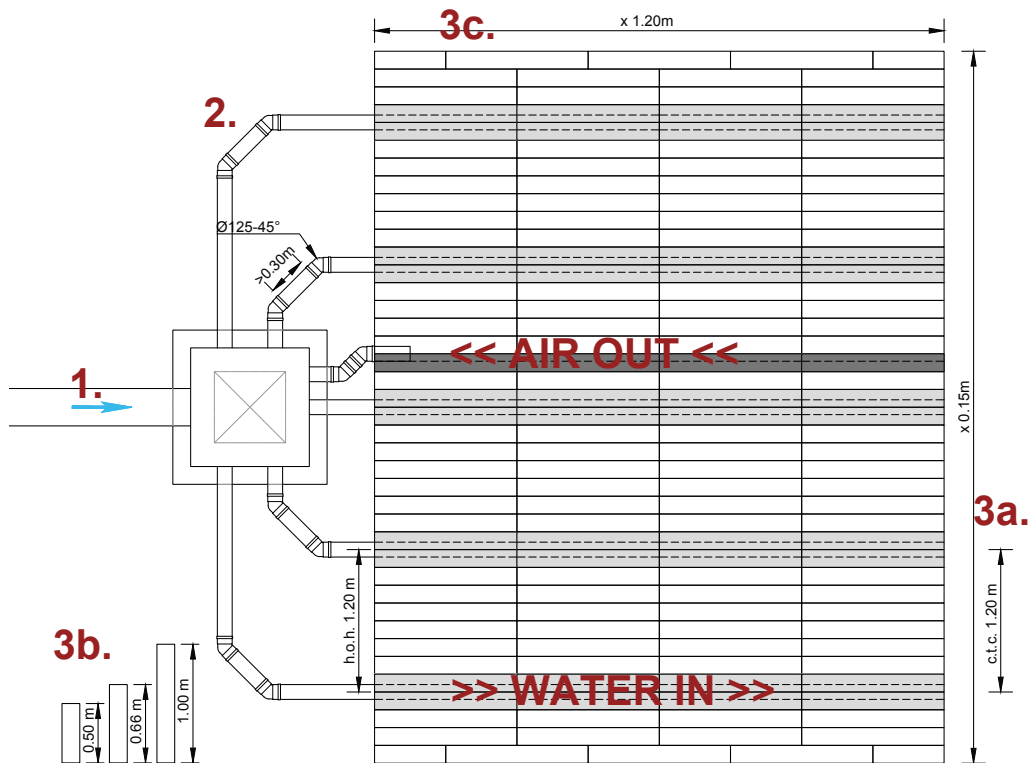

Figure 17: Design connections (top view)



**Step 4:** For a case and example calculation, see [Appendix 3](#)



## Guidelines for a CENTRAL BUFFER

The hydraulic capacity of the Rockflow stone wool buffer can be designed according to the rules below

Sizing: minimum number of connections  $\text{Ø}125 = \frac{Q_{\text{max},A} \text{ [l/s]}}{16 \text{ [l/s]}}$

Width:  $\left(\frac{Q_{\text{max},A} \text{ [l/s]}}{16 \text{ [l/s]}}\right) * 1.2 \text{ m} (=0,075 * Q_{\text{max},A} \text{ [l/s]})$

N.B. The width is the minimum width; wider is always possible.

Height: Choose based on cover layer; 0.50 m, 0.66 m or 1.00 m

$$\text{Length} = \frac{\text{Storage requirements [m]} * \text{Hard surfacing [m}^2\text{]}}{\left(\text{Br.} \left( \frac{Q_{\text{max}} \cdot A \left[ \frac{\text{l}}{\text{s}} \right]}{16 \left[ \frac{\text{l}}{\text{s}} \right]} \right) * 1.2 \text{m} \right) * \text{Hgt[m]} * \text{HR\%Rockflow}}$$

Length (simple):  $\text{Total volume Rockflow [m}^3\text{]} / (\text{Br[m]} * \text{Hgt[m]})$

# Step 4: Hydraulic design of Rockflow

## Step 4c: Ventilation and aeration of the Rockflow system

To allow a Rockflow buffer to fill rapidly with rainwater, it must be possible for the air present in the stone wool to escape rapidly. If this is not possible, then the filling speed and storage volume are limited by the presence of the air in the stone wool. Air moves through stone wool many times faster than through water. Air channels are also essential for optimum emptying of the system (by infiltration or by delayed discharge). To achieve an equilibrium between venting and aeration, there is at least one air channel at the top of each Rockflow system in the form of a half  $\text{Ø}125$ .



### Guideline recommendations for VENTING AND AERATION

- Half  $\text{Ø}125$  at the top of the Rockflow package approx. every 3.6 m (see basic principles)
- A minimum of 2 venting points per buffer from  $30 \text{ m}^3$  and above
- Max. gap between channels: 50 m for line buffers
- Fit at the highest point of the buffer

### In principle there are 3 venting and aeration options:

- 1 Preferably via the manhole. In this case, the manhole must be equipped with an open fan-type or grill manhole cover or a cover with holes.
  - 2 Via an open connection. Cover these with a grill.
  - 3 Via a block paving gully. Preferably use a different cover design than that used on the rainwater gullies and remove the inspection cover
- See [appendix 2](#) for photos of a number of solutions.

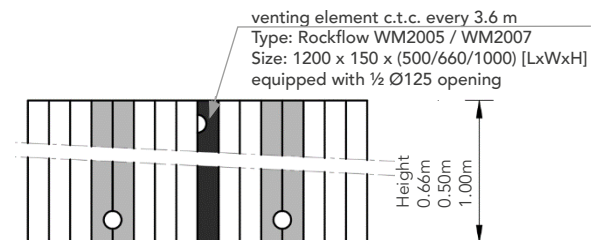

Figure 18: Venting element (cross section)

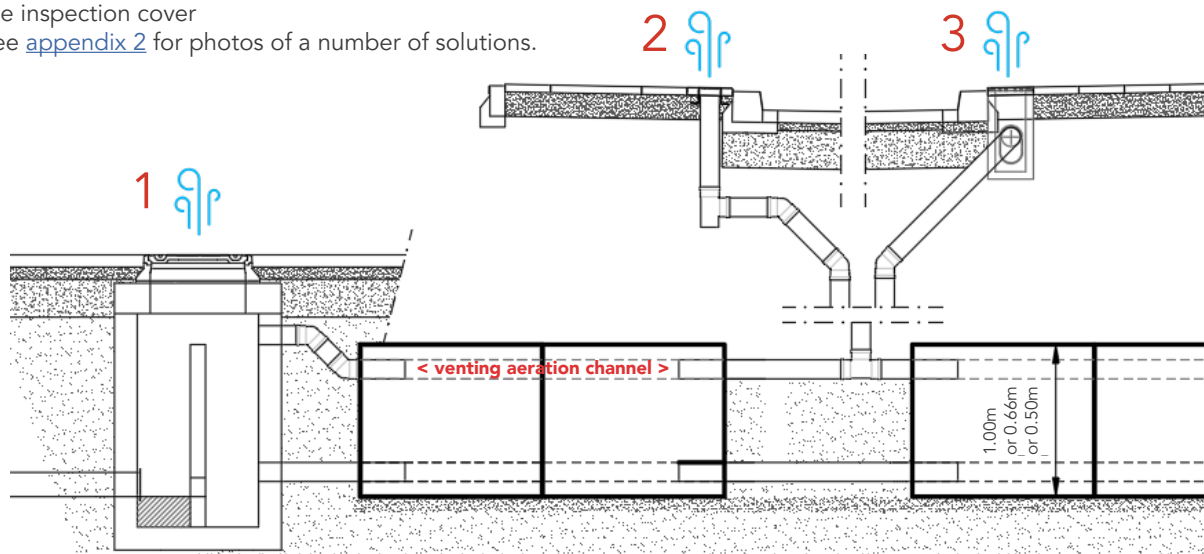

Figure 9: Examples of venting and aeration options (longitudinal section)

# Step 4: Hydraulic design of Rockflow

## Step 4d: Draining a Rockflow buffer

After a Rockflow buffer is filled with rainwater, it must also empty itself to make it available for the following shower. The time before a buffer needs to be available for the following shower (the emptying time) differs per project. 24 hours is often the specification for emptying, but also times up to 72 hours. The policymakers within the project's area determine the norm.

Our recommendation would be to make a good estimate of how soon the buffer will be filled again.

Emptying time: size of storage requirements vs. recurrence interval of showers

A buffer with a storage requirement of 20 mm should, in principle, certainly be empty again within 24 hours. The chance that a shower will fall that fills the entire buffer is higher than with a buffer with a 100 mm storage requirement.

In principle there are two ways for a Rockflow buffer to empty itself: via INFILTRATION to the soil, via DELAYED DISCHARGE or using a combination of the two. The combined solution is often necessary if the soil below has a low k value and the buffer would not be available in time using infiltration alone.

### Draining Rockflow using infiltration

To calculate the emptying speed to the soil via infiltration, you need to know the k value or permeability of the soil below. Since k values can be extremely variable between areas, we recommend that you always have the area tested where the buffer will be installed. This means that you can feel more confident that the system will operate correctly.

There are also tables that give an indication of the permeability of certain soil types. These tables can be useful for a preliminary rough estimate of the most suitable location within the project area to site an infiltration buffer. K value tests can then be carried out at the location that is expected to be most suitable.

To determine the emptying speed of an infiltration installation, RIONED<sup>5</sup> advises using the following formula:

$$l_{\text{eff}} = k * \frac{(F_{\text{wall}} * O_{\text{wall}}) + (F_{\text{soil}} * O_{\text{soil}})}{24 * 10 * A_{\text{hard surf.}}}$$

$l_{\text{eff}}$	emptying capacity of the infiltration installation [mm/h]
K	permeability underlying soil [m/day]
$O_{\text{wall}}$	wall surface area (Length + Width)*2 * Buffer height [m <sup>2</sup> ]
$F_{\text{wall}}$	factor equivalent wall surface area
$O_{\text{soil}}$	soil surface area (Length * Width) [m <sup>2</sup> ]
$F_{\text{soil}}$	factor equivalent soil surface area
$A_{\text{hard surf.}}$	draining surface area [ha]



**Step 4d: For a case and example calculation, see [Appendix 3](#)**

<sup>5</sup> RIONED: [www.riool.net](http://www.riool.net)

# Step 4: Hydraulic design of Rockflow

If the availability specification cannot be achieved using soil infiltration, the following solutions are possible:

- 1 Increase infiltration surface area by lowering the buffer height. Choosing elements 0.50 m high rather than 1.0 m increases the infiltration surface area of the soil. (Although the wall surface area is also reduced, this has less impact.)
- 2 Combining emptying by infiltration with delayed discharge (see next paragraph).

## Draining Rockflow via delayed discharge

A delayed discharge or drain is the appropriate solution in situations where the permeability of the underlying soil is extremely low or if infiltration is not permitted. By construction using delayed discharge or by correct dimensions of the drain, it is possible for the buffer to be emptied again within the required time period, making it available for the next rainfall.

There are roughly four types of construction that can be used (see Figure 20):

- A Opening (pinch valve) in the overflow wall
- B Opening in the bend of the overflow pipe
- C Adjustable shutter with discharge pipe
- D Vertical infiltration pipe

## Step 4e: Emergency overflow

It is always desirable to build an emergency overflow in a buffer system. The system is designed for a certain maximum volume. In a downpour that is greater than the design rainfall, the emergency overflow comes into operation. This prevents local flooding.

There are three types of emergency overflow system (see Figure 20).

- 1 Overflow wall, top is level with the top of the buffer
- 2 Overflow pipe, top is level with the top of the buffer
- 3 Overflow drain, top is level with the top of the buffer

The excess water should be discharged to another water system which has surplus capacity.

How useful and necessary an emergency overflow is, is dependent on:

- the expected recurrence interval of showers
- storage requirements
- the risks to the locality if standing water develops on the road

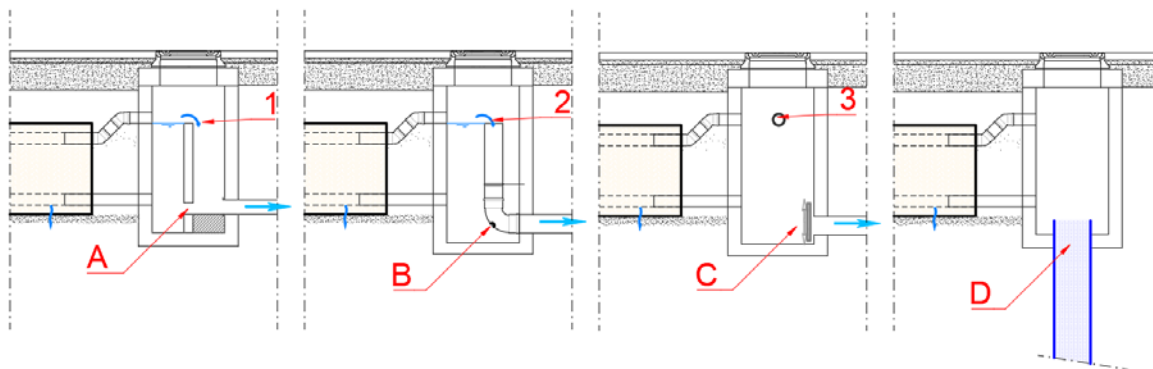

Figure 20: Draining and emergency overflow (cross sections)

# Step 5: Ease of maintenance and inspection

To ensure that the Rockflow system continues to work correctly, the system must be maintained by inspection and cleaning of the Rockflow water transport channels. This maintenance can only take place if these channels are accessible. This can be taken into account of in the design. The water transport channels in the Rockflow system must be accessible for the inspection camera and the spraying nozzle for cleaning, otherwise maintenance is not possible.

During the design, ensure that the water transport channels are accessible via the inspection manholes and design using bends no greater than 45 degrees and a distance of at least 0.30 m between successive bends. This is easier to achieve in a line buffer than in a central buffer.

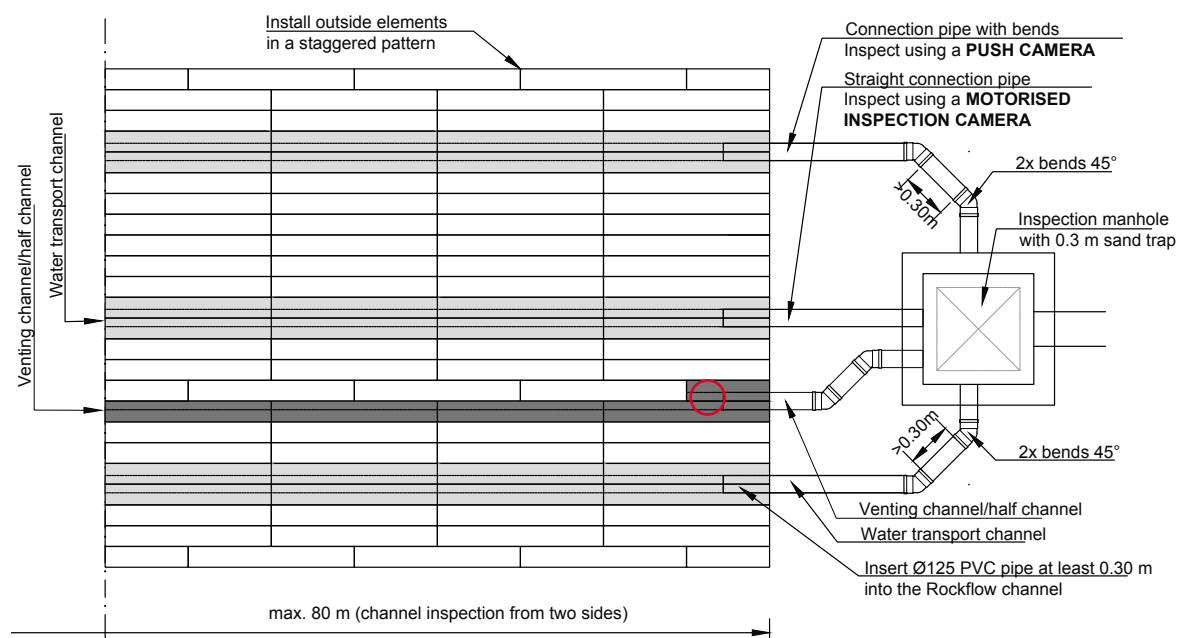

Figure 21: Design with inspection in mind

As indicated in Figure 21, it is desirable that the elements are evenly staggered (V) during installation. This creates a more stable construction. At a minimum, this staggered construction is desirable on the external edges of the Rockflow package and for the venting element. Since the venting element only has half a channel, it is not easy to connect a circular pipe to it. However, it is possible to install a half element (O) that also has a half channel. This makes it easier to implement the connection between the stone wool and a pipe. Moreover, it also creates the required staggered effect.

# Step 5: Ease of maintenance and inspection

In a standard 1000x1000 manhole, a maximum of 9 connections can be installed. With the standard distance of 1.2 m between the channels in Rockflow, a maximum buffer width of 11 m can be achieved.

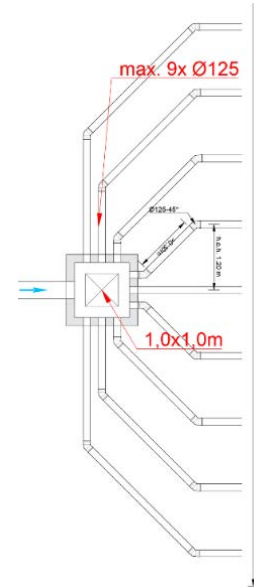
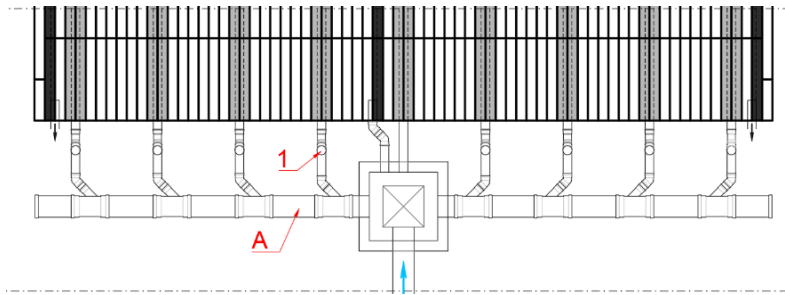
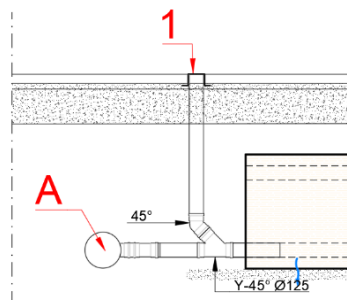

Figure 22: Maximum number of connections (top view)



For wider buffers, there is also the option of using a distribution pipe coming from the manhole (see Figure 23). To enable inspection and cleaning of the channels, it is essential that a flushing system (1) is present between the distribution pipe (A) and the Rockflow system.

Figure 23 a+b: Flushing systems and distribution pipe (top view en cross section)

To optimise the cleaning process and collect dirt flowing out of the pipelines and channels, it is important that there is a sand trap of at least 0.3 m in the manholes (see Figure 24 S).

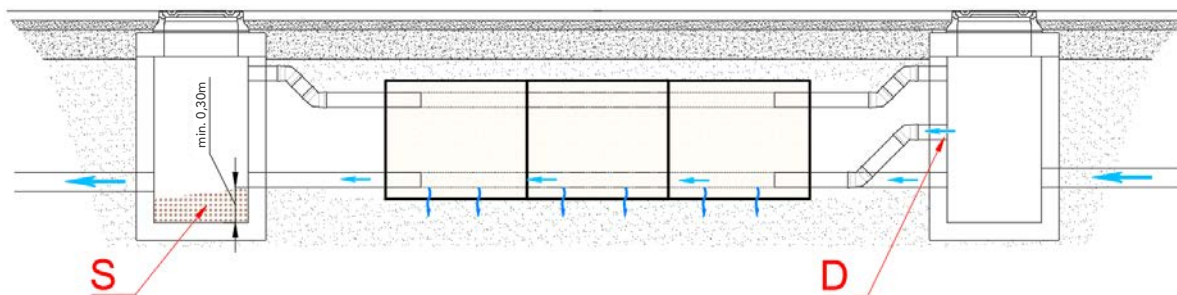

Figure 24: Sand trap (cross section):

Particularly for manholes with multiple Ø125 connections and high storage requirements, a number of Ø125 connections could be installed higher in the manhole (see Figure 24 D). This ensures that the first dirt during a shower is concentrated more in the lower-lying channels. Best practice is to place the channels that have the shortest distance between the manhole and Rockflow as the lowest channels in the system design. Channels with a short distance between the manhole and the buffer are in general more accessible and can therefore be cleaned more easily.



# Step 5: Ease of maintenance and inspection

## Avoid dead ends

If a buffer is designed on the basis of a single-sided rainwater supply, from a maintenance point of view, it is advisable to connect the water transport channels (water IN) to each other on the opposite side (see Figure 25 E). This avoids creating dead ends in the water transport channels where dirt can gather.

If the venting pipe is only connected on one side, the final Rockflow element does not need to have an opening (solid element, see Figure 25 A). This prevents dirt entering the venting channel from the end.

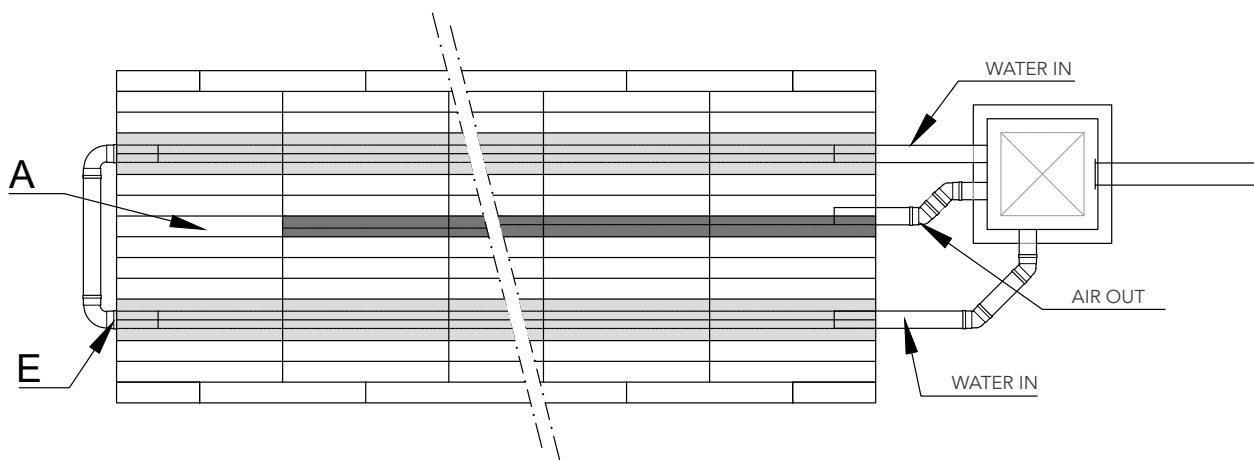

Figure 25: Finishing water transport channels (top view)

## Line buffer-gully connection

For a line buffer underneath a street or car park, connections between the gully and the Rockflow package are often required. For a more rapid uptake of rainwater, use a y-section for the connection. This improves the water flow into the buffer. Depending on how the gully is connected, it may also be possible to carry out partial inspections or cleaning through the gully.

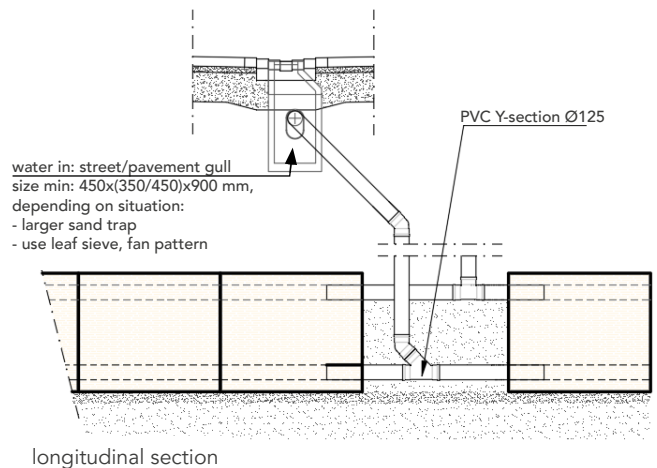

Figure 26: Gully connection (cross section)

Instructions for maintenance, inspection (also for system delivery inspection) can be downloaded from the Rockflow website.



# Step 6: Important specification considerations

## Rockflow's services

After the design is completed, you can have it assessed by the Rockflow team, free of charge. Contact us via the contact details on the website or send an email to [rain@rockwool.com](mailto:rain@rockwool.com).

When the design has been finalised, it is time to prepare the estimate or contract.

The estimate texts can also be found on our website ([rain.rockwool.com](https://rain.rockwool.com)) under downloads > technical drawings.



The design texts not only specify the items that are related to the Rockflow elements, but also important considerations related to implementation.

For the Dutch contract guidelines (RAW), an RSX file is available from which you can copy the items.

In sections 1, 2.1 and 3 of the Dutch contract guidelines (RAW) provisions are included to safeguard the quality of the implementation.

In section 2.2, in addition to the items for installing Rockflow, extra sections have also been added to safeguard the quality of the implementation. The following items are important for quality assurance:

- Use gullies with a large sand trap and possibly equipped with a leaf sieve
- Level the foundation layer and if necessary, add a regulating course of sand
- After completion of the project: remove filling sand and clean gullies
- Inspect the Rockflow channels (completion inspection)
- Coordination and agreement with third parties (incl. Rockflow)

Good luck preparing your design!

# Appendix 1: Overview of maximum axle load during



RAINWATER SYSTEMS

## Maximum axle loads



### Construction phase

Coverage on Rockflow in the implementation phase (construction phase)	Maximum axle loads that are permissible during implementation on the compacted <sup>[1]</sup> foundation package <sup>[2]</sup>			
	Rockflow WM2005		Rockflow WM2007	
	Axle loads <sup>[3]</sup>	Single wheel load	Axle loads <sup>[3]</sup>	Single wheel load
25 - 45 cm	< 3 ton	< 0.8 ton	< 6 ton	< 1.5 ton
45 - 65 cm	< 6 ton	< 1.5 ton	< 10 ton	< 2.5 ton
> 65 cm	< 10 ton	< 2.5 ton	< 15 ton	< 3.7 ton

<sup>[1]</sup> In accordance with standard RAW provisions 2015 art. 80.16.05) delivery, application and compaction.

<sup>[2]</sup> Construction of foundation package minimum 0.30m mixing granulate 0 / 31.5 (NEN-EN 13242 (2015) + possibly sand in sandbed (Standard RAW provision 2015 art. 22.06.03).

<sup>[3]</sup> Axle load based on rear axle with double tires (NEN-EN 1991-2 par. 4.3.2), Wheel print 0.4m x 0.4m.



### Usage phase

Traffic category Axle load	Minimum installation depth (top of buffer to ground level)	
	Rockflow WM2005	Rockflow WM2007
Green (no traffic)	> 30 cm (sand)	NA
6 ton	40 cm	40 cm
10 ton	40 cm	40 cm
15 ton	60 cm	40 cm
20 ton	75 cm	45 cm

The road construction consists of the following layers:

- 10 cm road or asphalt
- 30 cm foundation of mixed granulate (WM2009: 25 cm)
- Variable sand layer thicknesses

# Appendix 1: Overview of maximum axle load during



















RAINWATER SYSTEMS

## Guidelines for choosing axle-loads for Rockflow



Usage phase

Type of area	Expected loads	Max axle-loads for the design	Remark
Parking lot	   	< 10 t < 15 t	At < 10 t not accessible for trucks
Residential area	   	< 15 t	
City	   	< 20 t	
Industry / Highway	  	20 t	Pay attention to special and heavy duty transport.
	When using asphalt-top layer, always take the parameters of 20 t axle-load (Usage phase). In the construction phase you must drive with the asphalt trucks / paving machine over the compacted foundation.		

# Appendix 2: Venting and aeration, examples

## Ventilation and aeration of the Rockflow system

Air out: Venting point (gully or equivalent)  
 Type TBS: STR STR 9301  
 External dimensions 300x300x600 mm  
 Pattern: perforated with holes  
 N.B.: Remove inspection cover.

Guideline:  
 Minimum 2 per buffer Max.  
 every 50 m  
 Every 100 m<sup>3</sup>  
 Highest point of the buffer

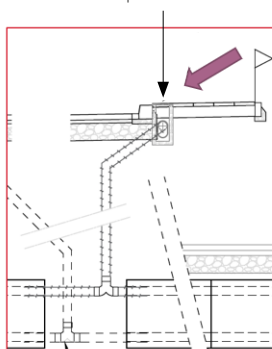

Venting via a gooseneck vent pipe

(tiled path) gully  
 Preferably with a different cover



Manhole with grill

Venting grill 17x17  
 type AMSTEEL17  
 Supplier: [www.greenmax.eu](http://www.greenmax.eu)

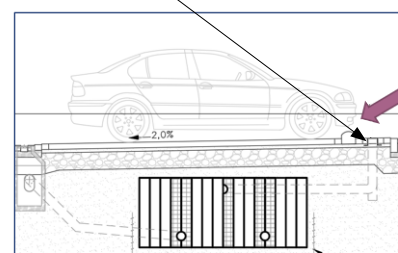

Grill 17 x 17



N.B. Remove inspection cover from  
 gully/venting gully



# Appendix 3: Design case with example calculations

## Step 1: Calculate water retention and volume of Rockflow

Residential street 1 km long and 10 m wide. Assuming 100 % hard surfacing.

Sewer system is designed to Shower Level09 and 60 mm storage requirement.

Task: **Determine the required quantity of Rockflow.**

**Water storage requirement** =  $((1.000 \times 10) \times 0.06) = 600 \text{ m}^3 / 95\% = 632 \text{ m}^3$  Rockflow.

(Based only on the hydraulic calculations for Level09, this would be 417 m<sup>3</sup>, 20 mm less storage.)

## Step 2: Choose location and type of Rockflow system

In this example the choice was made for a line buffer in step 3 and a central buffer in step 4.

## Step 3: Determine maximum buffer height and choice of elements

A residential street 1 km long and 10 m wide with new asphalt (0.20 m thick). Assume 100 % hard surfacing. Sewer system designed for Level09, with a 60 mm storage requirement.

A Rockflow line buffer was chosen. Groundwater level/ average maximum groundwater level is 2 m below ground level.

Task: **Determine the street structure and give the maximum axle load or wheel loads in the construction phase.**

- Rockflow volume: 634 m<sup>3</sup> (determined in case study 1)
  - Residential street with asphalt, minimum cover layer during operation, see [appendix 1](#): 20 tonne axle load
    - Rockflow WM2005 = 0.75 m
    - Rockflow WM2007 = 0.45 m
- Given the depth of the groundwater (2 m below ground level), we would advise choosing Rockflow element type WM2005.

From the cost point of view, WM2005 is cheaper than WM2007. The buffer will be installed in a residential street where there are often many cables and pipelines crossing the buffer. A thicker cover layer >0.75 m will be better during operation.

- Maximum axle load or wheel load during construction ON THE COMPACTED FOUNDATION PACKAGE: for type WM2005. If a 10-tonne axle load / <2.5 tonnes wheel load is permitted for a foundation package (including a sand layer) of >0.65 m.
- **N.B.** Taking into account the asphalt layer (in this example 0.20 m), the minimum cover layer is therefore 0.65 m (cover layer in construction phase) + 0.20 m (asphalt during operational phase) = 0.85 m cover layer on top of Rockflow.
- Determine the maximum buffer height: 2.00 m (distance ground level to average maximum groundwater level) – 0.85 m (minimum cover layer) = 1.15 m maximum.
- Choose the correct element height: in this case, height is 1.00 m (a lower element is another option, i.e. 0.66 m or 0.50 m, but there is enough space for the tallest element).

If the underlying soil has a very poor infiltration value, it is probably better to choose lower element heights. This enables you to create more surface area for infiltration (see page 25).

- Road composition: 0.20 m asphalt  
0.30 m rubble foundations  
Important note:  
all road construction calculations are based on **MINIMUM 0.30 M RUBBLE FOUNDATIONS**
  - 0.35 m sand for sand bed
  - 1.00 m Rockflow
  - 0.10 m sand voor regulating course
- **Length = multiples of 1.20 m**

In this example, the street is 1 km long. The effective length compared to the design is approx. 800 m. Operational length > 800.4 m  
Because the Rockflow elements are 1.20 m long, the total length of the buffer must be a multiple of 1.20 m. (667 x 1.20 m rows)  
For control and maintenance purposes, we recommend a maximum line buffer length of 40 m if the buffer is accessible on one side only and has rainwater supply from one side; 80 m if there is access and rainwater supply on two sides.  
Refer to Step 4 for the maximum hydraulic dimensions of a line buffer / central buffer.
- **Width = multiples of 0.15 m**

Total buffer capacity: 634 m<sup>3</sup>/800.4  
Effective width = 0.79 m wide  
Implementation width > 0.90 m  
Because the Rockflow elements are 0.15 m wide, the total width of the buffer must be a multiple of 0.15 m. (6 elements, each with a width of 0.15 m.)

# Appendix 3: Design case with example calculations

## Step 4: Example of a central buffer

A residential street 1 km long and 10 m wide with new asphalt (0.20 m thick). Assume 100 % hard surfacing. Sewer system designed for Levek09, with a 60 mm storage requirement.

A Rockflow central buffer was chosen. Total storage and height were determined in Steps 2 and 3:

Water retention volume: 600 m<sup>3</sup>. Rockflow volume: 634 m<sup>3</sup>. Height: 1.0 m.

Task: **Determine the dimensions of the buffer**

- Rainwater drainage sewer on a slope of 1:2000 -> with a Q<sub>max</sub> of 160 l/s/ha. The last strand has a Q<sub>max</sub> of 160 l/s/ha \* (10\*1000) – 160 l/s diameter 700 BTN pipeline (Chezy formula)
- Minimum number Ø125: 160 [l/s] / 16 [l/s] = 10 elements
- Width of the buffer: = 10 \*c.t.c. 1.2 m = 12 m
- Length: 634 m<sup>3</sup>/(12\*1.0) = 52.8 m. N.B. This is larger than the 40 m maximum length. Make the buffer wider.
- Modified width: 14 channels \* 1.2 m = 16.8 m. This gives a length of 37.7 m > 38.4 m final length, using elements 1.2 m long.
- Buffer dimensions LxWxH = 38.4 x 16.8 x 10.0 = 645 m<sup>3</sup> Rockflow. This is approx. 11 m<sup>3</sup> too much. If this is not desirable, you can decrease the width by steps of 0.15 m (i.e. the width of one element). The following will apply: 11m<sup>3</sup>/ (38.4 length\*1.0 height) = 0.29 m. This equals approx. 2 widths of x 0.15 m by which the width could be reduced. 38.4 x 16.5 x 1.0 = 633.6 m<sup>3</sup> of Rockflow
- Check the ratio width: length = 1.0 : >1.2 This is acceptable.
- Check the absorption capacity of the channels: Q<sub>max</sub> / (Number of channels \* Length) < 0.4 (160/(14\*38.4)) = 0.3. This is not acceptable.

## Step 4d: Infiltration calculation

Task: Determine the emptying capacity and the statistical emptying time

Buffer dimensions LxWxH = 38.4 m x 16.8x 1.0 m = 645 m<sup>3</sup> of Rockflow. Storage requirements 60 mm. Availability within 24 hours. K value underlying soil levels = 0.5 m/day

$$i_{\text{eff}} = k * \frac{(F_{\text{wall}} * O_{\text{wall}}) + (F_{\text{soil}} * O_{\text{soil}})}{24 * 10 * \text{Average hard surfacing}}$$

$$i_{\text{eff}} = 0.5 * 2.9 = 1.46 \text{ mm/h}$$

Storage requirement = 60 mm/1.46 mm/h = 41 hours statistical emptying time. Therefore, the buffer design does not fulfil the 24-hour availability requirement.

Possible solutions to comply with the 24-hour availability requirement:

Increase surface area by lowering the buffer height. Using elements 0.5 m high provides a greater soil surface area. 645 m<sup>3</sup> with Rockflow elements 0.5 m high gives a soil surface area of 1,290 m<sup>2</sup>.  $i_{\text{eff}}$  based on soil alone:  $0.5 * (1290/240) = 2.7 \text{ mm/h} > 40 \text{ hours}$  statistical emptying time for the storage requirements set. This meets the design specifications.

Implement delayed discharge drainage (see paragraph: Draining Rockflow via delayed discharge, [page 30](#))

# Appendix 4: Most important design considerations

A brief overview of the majority of the most important considerations for designing a Rockflow system, as a final check of your design.

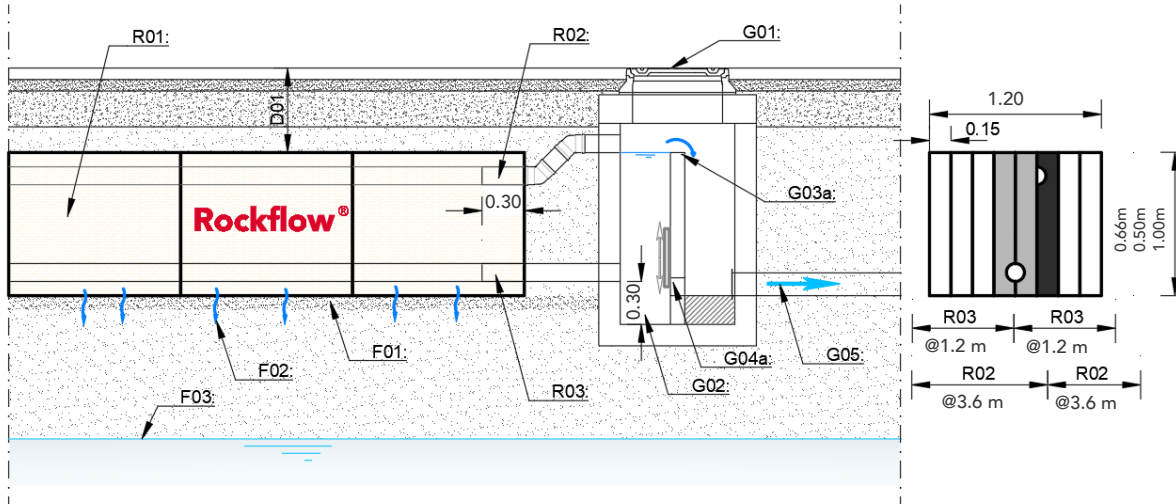

Section	Check
D01	Cover layer determined for the construction and design phase, in relation to the expected wheel loads
F01	Smooth foundation, possibly with an extra regulating course in the design
F02	K value of the underlying soil must be known for an infiltration buffer
F03	Groundwater level and average maximum groundwater level must be known for determining the height of the elements
R01	Determining the Rockflow element height and type
R02	Design of the venting (Air OUT)
R03	Designing and determining number of the water transport channels (Water IN)
G01	Manholes for inspection and cleaning, possibly as venting points
G02	Manholes equipped with a sand trap min. 0.30 m
G03a	Design emergency overflow (if necessary)
G04a	Design delayed discharge (if necessary)
G05	Drainage pipe for emergency overflow and/or delayed discharge









ROCKWOOL Group is the world leader in stone wool products, from building insulation to acoustic ceilings, external cladding systems to horticultural solutions, engineered fibres for industrial use to insulation for the process industry and marine & offshore. We are committed to enriching the lives of everyone who experiences our products and services, and to helping customers and communities tackle many of today's biggest sustainability and development challenges including energy consumption, noise pollution, fire resilience, water scarcity, urban flooding and more.

RAINWATER SYSTEMS



**ROCKWOOL®**

Visiting address

**ROCKWOOL Rainwater Systems**

Delfstoffenweg 2  
6045 JH Roermond  
The Netherlands

Postal address

**ROCKWOOL Rainwater Systems**

P.O. Box 1160  
6040 KD Roermond  
The Netherlands

Tel: +31 4 75 35 35 55  
Email: [rockflow@rockwool.com](mailto:rockflow@rockwool.com)  
[rain.rockwool.com](http://rain.rockwool.com)